



Short Form Catalog

With an unusually diverse selection of more than 60 Ethernet and Fiber Optic Communications products, TC Communications offers a wide variety of networking solutions:

Ethernet/IP:

- » GigE Multi-Service Backbone Networks
- » Industrial & Rugged Ethernet
- » TDM to Ethernet Migration
- » Ethernet over T1/E1, T3/E3
- » Ethernet alternative to SONET/SDH
- » Long Distance Ethernet

Data:

- » Complete Serial Data Connectivity
- » Convert MM Fiber to SM (& vice versa)
- » Extend Distances

Voice:

- » VoIP Virtual PBX
- » Extend Telephones via RS232, Fiber or Ethernet
- » Multiplex Telephone, T1/E1 & Analog
- » Cellular Backhaul & Access
- » Emergency Radio & Telephone Links

Industrial:

- » Power Utilities (SCADA, Teleprotection, etc.)
- » Transportation (ITS, Highways, Railroads, etc.)
- » Oil & Gas (Pipelines, Refineries, etc.)
- » IP Video Surveillance & Security
- » Water Treatment Plants
- » Factory Floor

Short Form Catalog

ETHERNET/IP BACKBONE



The JumboSwitch® Industrial Gigabit Ethernet Modular Switch seamlessly integrates Ethernet, Data and Voice over one cost efficient Ethernet/IP platform.

Ideal as an Ethernet/IP backbone or sub-network, the JumboSwitch offers levels of scalability, flexibility and connectivity that standard industrial Ethernet Switches cannot match.

Discover why network professionals are migrating their existing legacy networks, (including aging and less IP-friendly SONET/SDH systems), to a modern JumboSwitch network.

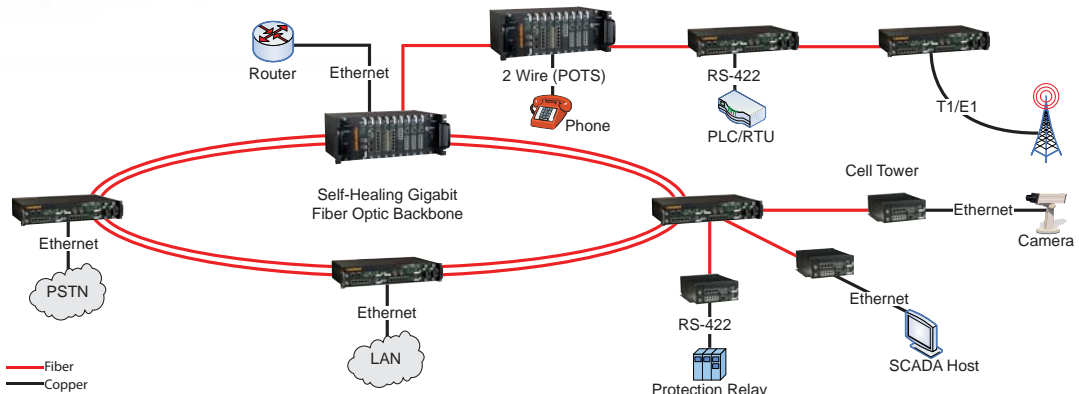

JumboSwitch Application

ETHERNET & INDUSTRIAL ETHERNET

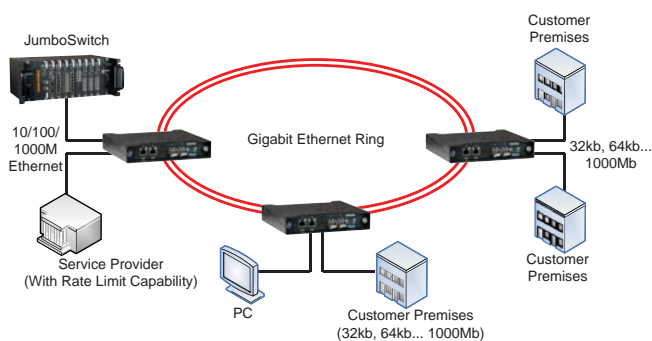

TC3340 Application

You get to choose from a full spectrum of Ethernet and Industrial Ethernet solutions.

Specific products include all types of Ethernet Switches; Media Converters; a VoIP+ Virtual PBX; Ethernet, Telephone T1/E1 & Serial Data Multiplexers; and, Ethernet Telephone Extenders.

Industrial Ethernet and Industrial grade versions of all Ethernet products are available with extreme temperature ranges (-40°C to +80°C), special components, connectors & circuitry. Conformal coating is optional.

FIBER OPTIC MODEMS

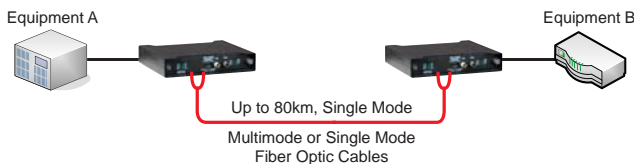

TC1705 Application

No single vendor can match TC Communications' line of Data, T1/E1 and T3/E3 Fiber Optic Modems.

Fifteen different multimode and single mode modems combine to offer more than 20 interface options (T1/E1, T3/E3, RS232, RS485, RS422, RS366, Dry Contact, etc.) for network connectivity issues.

Configurations include point-to-point, multi-drop, ring, self-healing ring and bus. Data rates range from 300 bps to 10Mbps. Industrial hardened is optional.

FIBER OPTIC MULTIPLEXERS

Simply put, TC Communications offers the most extensive line of fiber optic multiplexers in the communications industry.

Twelve different models combine to multiplex combinations of Serial Data, Ethernet, T1/E1, Telephone, 2/4-Wire Analog, Audio, Intercom or Dry Contact.

You will find a TC Communications' multiplexer connectivity solution for virtually every network application.

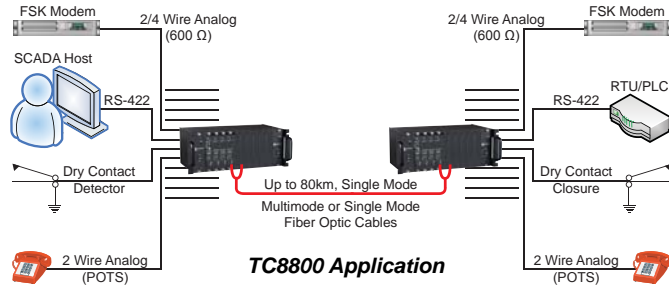

VoIP, VOICE MULTIPLEXERS & TELEPHONE EXTENDERS

Voice and telephone network solutions include a VoIP Gateway, Voice Multiplexers and Network Telephone Extenders.

The VoIP+ Virtual PBX is a complete telephony solution and is available industrial hardened.

Multiplexers offer various combinations of Telephone, T1, E1, 2/4 Wire Analog, Audio, Intercom, Dry Contacts, RS232/422 and Ethernet.

Five different Telephone Extenders convert Ethernet, Fiber Optic or RS232 interfaces into voice networks by simply plugging in a telephone set.

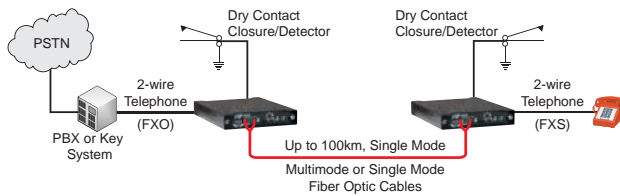

SINGLE MODE & MULTIMODE CONVERTERS

Five specialized single mode-to-multimode (and vice versa) converters combine to offer the most advanced and comprehensive product line of its type available in the marketplace.

Mode conversions provide several key network benefits:

- Cross-connecting fiber types
- Re-generating optical signals
- Extending transmission distances
- Doubling Fiber Cable Usage

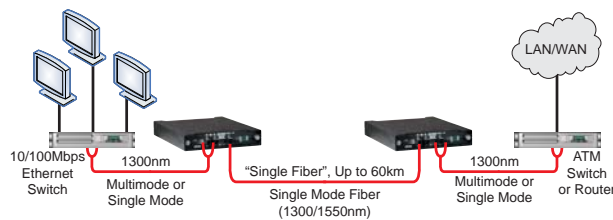

MULTI-DROP FIBER MODEMS, MULTIPLEXERS & SERIAL DEVICES

TC offers a wide range of Multi-Drop serial data connectivity products for SCADA, Process Control and Traffic Control fiber optic networks.

Seven different Fiber Modems, Multiplexers and a Broadcast & Receive Device provide mission critical solutions for self-healing ring, ring and string network topologies.

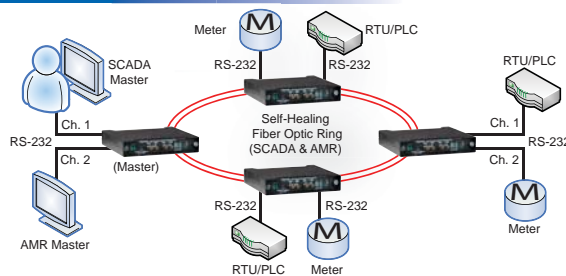

Product List

ETHERNET/IP BACKBONE	
JumboSwitch®: Industrial Ethernet Modular Switch (TC3840 Series)	
JumboSwitch Main & Management Cards:	
• JumboSwitch Main Card (2U & 4U Chassis Only).....	TC3840-1
• JumboSwitch Main + 4-Port 10/100 Card (2U Chassis Only).....	TC3840-4
• JumboSwitch MGMT Card (2U & 4U Chassis Only).....	TC3840-2
• JumboSwitch Main/MGMT "Combo" Card (2S & 1U Chassis Only).....	TC3840-3
JumboSwitch Interface Cards:	
• 6-Port 10/100/1000 Copper Ethernet Switch.....	TC3841
• 6-Port SFP Gigabit Ethernet Switch.....	TC3842-1
• 3-Ports SFP Gigabit Ethernet Switch + 3-ports 100Base-FX SFP.....	TC3842-2
• 6-Ports 100Base-FX SFP.....	TC3842-3
• Ethernet-over-T1/E1.....	TC3844-1
• Ethernet-over-T3/E3.....	TC3844-3
• T1/E1-over-IP.....	TC3845-1
• T3/E3-over-IP.....	TC3845-3
• G.703/64K-over-IP.....	TC3846-1
• C37.94-over-IP.....	TC3846-2
• 600Ω Analog & Dry Contact-over-IP.....	TC3846-6
• RS232/422/485 Serial Server.....	TC3847-1
• Turbo Serial Server (for low latency applications).....	TC3847-3
• Dry Contact-over-IP.....	TC3847-5
• VolIP+ Virtual PBX (4-Port FXS + 1-Port FXO).....	TC3848-1
• VolIP+ Virtual PBX (5-Port FXO).....	TC3848-2
• Modem-over-IP (4-Port FXS).....	TC3848-3
• Modem-over-IP (4-Port FXO).....	TC3848-4
ETHERNET SWITCHES	
Managed 6-Port 10/100/1000 +2 Port 10/100 DIN Rail Mount.....	TC3314
Managed 2-Port 10/100/1000 + 2-Port 1000SX/LX SFP.....	TC3340
Managed 6-Port 10/100 + 2-Port 1000SX/LX SFP (Self-Healing Ring).....	TC3820
Unmanaged 6-Port 10/100 + 2-Port 100FX (Self-Healing Ring).....	TC3720
Unmanaged 4-Port 10/100 + 1-Port 100FX.....	TC3705
Unmanaged 6-Port 10/100 + 2-Port 100FX.....	TC3715
ETHERNET MEDIA CONVERTERS	
10/100/1000 Media Converter.....	TC3301
10/100 Media Converter/Switch (Compact Chassis: 1.13"x5"x2.6").....	TC3212
3-Port 10/100 + 1-Port 100FX Media Converter/Switch.....	TC3240
10/100 Media Converter.....	TC3210
10BaseT Media Converter (Compact Chassis: 0.88"x3.96"x1.73").....	TC3105
10BaseT Media Converter (Rack/Standalone).....	TC3105R/S
Serial-to-Ethernet Converter.....	TC3400/3420
FIBER OPTIC MODEMS	
Multi-Interface (RS232/422/485/530, TTL & V.35).....	TC1705
Hi-Speed Multi-Interface (RS232/422/485/530, TTL & V.35).....	TC1710
Hi-Speed RS422/449.....	TC1720
T1/E1 (Compact Chassis: 1.13"x5"x2.6").....	TC1630
T1/E1 (Rack/Standalone).....	TC1630R/S
T3/E3.....	TC1680
RS232 (Sync/Async).....	TC1100
RS232 w/ Controls.....	TC1200
RS366 "dial-up".....	TC1230
Sync RS422/449.....	TC1504
RS422/485.....	TC1520
RS232/422/485.....	TC1540
Multi-Drop Self-Healing Ring.....	TC2100
Multi-Drop Bus/String.....	TC2200
Hi-Speed Multi-Drop Self-Healing Ring.....	TC2400
FIBER OPTIC MULTIPLEXERS	
Telephone, Analog & Data (2-28 Ch.).....	TC8800
Analog/Intercom & Data (4-28 Ch.).....	TC8000
T1/E1, Data/Voice & Ethernet Fiber Optic Multiplexer (4-24 Ch.).....	TC8518
T1 & E1 (1-4 Ch.).....	TC8300
T1, E1 (1-4 Ch.) & Data w/ Ethernet Bridge.....	TC8510
Telephone (1-4 Ch.), Data & Ethernet.....	TC8520
Data (4-12 Ch.) & Ethernet.....	TC8530
RS232 (Compact Chassis: 0.88"x3.96"x1.73") (4/8 Ch.).....	TC1880
Multi-interface (RS232/422/485, TTL, Dry Contacts) (8/16 Ch.).....	TC8116
Multi-interface (RS232/422/485, TTL, Dry Contacts) (8-128 Ch.).....	TC8108
Multi-Drop Self-Healing Ring (4/8/12 Ch.).....	TC2800
Multi-drop Bus/String (4-12 Ch.).....	TC2900
Multi-drop Self-Healing Ring w/ Channel Mapping (4-12 Ch.).....	TC2850
WDM (2 Ch.).....	TC4001
TELEPHONE & AUDIO EXTENDERS	
Fiber Telephone Extender.....	TC1901
RS232 Telephone Extender.....	TC1900
Ethernet Telephone Extender.....	TC1910
Fiber Telephone & Dry Contact Extender.....	TC1905
Fiber Telephone Extender (1 fiber, bi-directional).....	TC1903
Telephone Party-Line Digital Mixer.....	TC8930
Emergency Phone Line Bridge / Crash Phone.....	TC8938
MULTIMODE-TO-SINGLE MODE CONVERTERS/REPEATERS	
MM-to-SM Hi-Speed (to 1,000 Mbps).....	TC3006
MM-to-SM (to 622 Mbps).....	TC3004
MM-to-SM (to 200 Mbps).....	TC3005
MM-to-SM w/ WDM (to 200 Mbps).....	TC3007
MM-to-SM Lo-Speed (to 10 Mbps).....	TC3020
BROADCAST & RECEIVE DEVICE	
Broadcast & Receive Device (SCADA Applications).....	TC8916
CAGE & CHASSIS OPTIONS	
4U High 19" Rackmount Card Cage.....	TCRM191/192
1U High 19" Rackmount Card Cage.....	TCRM195/196
JumboSwitch 4U High 19" Rackmount Card Cage.....	TCRM197
JumboSwitch 2U High 19" Rackmount Card Cage.....	TCRM198
JumboSwitch 1U High 19" Rackmount Card Cage.....	TCRM199
JumboSwitch 1U High 19" Rackmount Card Cage (2 Interfaces).....	TCRM199I
JumboSwitch 2-Card Standalone Chassis.....	TCSD11-2



TC COMMUNICATIONS INC.® 17881 Cartwright Road, Irvine, CA 92614 | All products are designed and made in the U.S.A.
 Phone: 1-800-569-4736 • Intl: +1 (949) 852-1972 | sales@tccomm.com • www.tccomm.com • www.jumboswitch.com